

# Data Sheet

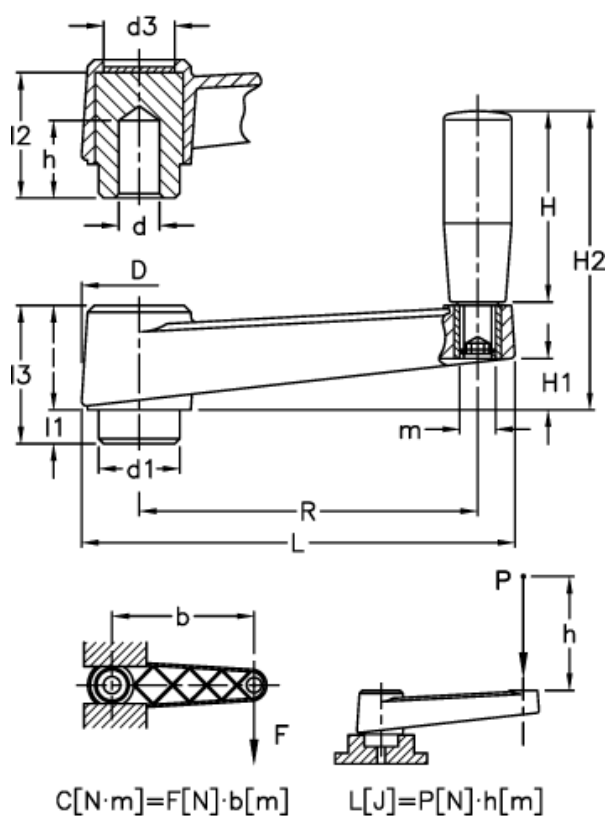

Article number: 2301044491  
 Description: E+G Crank handle  
 MT.160

## Measures



C (N m) = 450	H2 = 130	R = 160
D = 45	l = 40	
d1 = 34	L = 198	
d3 = 27	L (J) = 55	
d H9 = 10	l1 = 15	
H = 90	l2 = 49	
h = 30	l3 = 55	
H1 = 23	m = M10	